

**OPERADOR DE PORTA**

1 / 5

**OPERADOR DE 2 FOLHAS ABERTURA LATERAL**

FECHAMENTO PARA A DIREITA  
OU  
ABERTURA PARA ESQUERDA

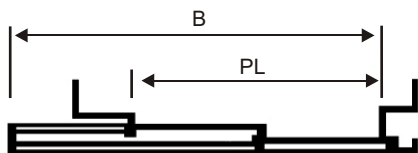

REF. : **OP/D - 2L**

FECHAMENTO PARA A ESQUERDA  
OU  
ABERTURA PARA DIREITA

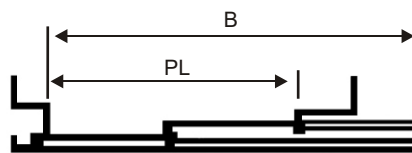

REF. : **OP/E - 2L**

PL	B
700	1.090
800	1.240
900	1.390
1.000	1.540
1.100	1.690
1.200	1.840

**OPERADOR DE 3 FOLHAS ABERTURA LATERAL**

FECHAMENTO PARA A DIREITA  
OU  
ABERTURA PARA ESQUERDA

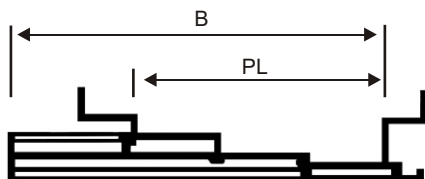

REF. : **OP/D - 3L**

FECHAMENTO PARA A ESQUERDA  
OU  
ABERTURA PARA DIREITA

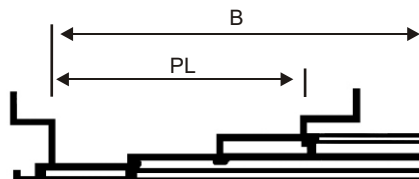

REF. : **OP/E - 3L**

PL	B
700	975
800	1.110
900	1.240
1.000	1.375
1.100	1.510

**OPERADOR DE PORTA DE 2 FOLHAS ABERTURA CENTRAL**

**2 / 5**

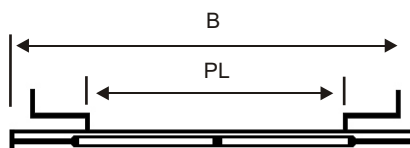

PL	B
700	1.480
800	1.680
900	1.880
1.000	2.080
1.100	2.280
1.200	2.480

**OPERADOR DE 2 FOLHAS CENTRAL PARA PORTA AUTOMÁTICA**

3 / 5

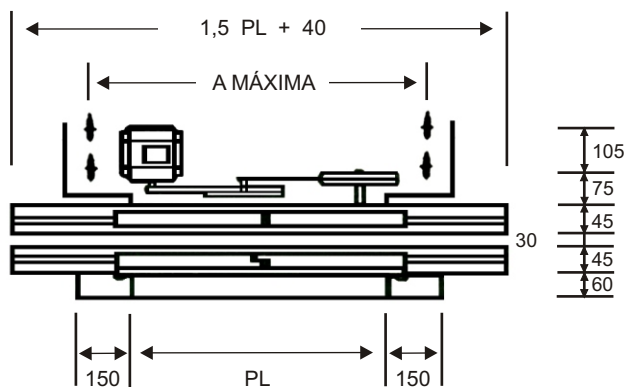
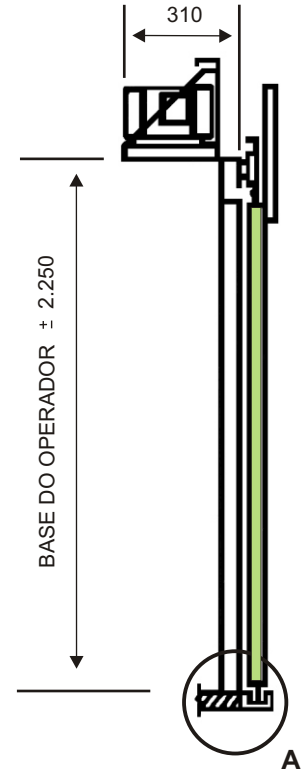
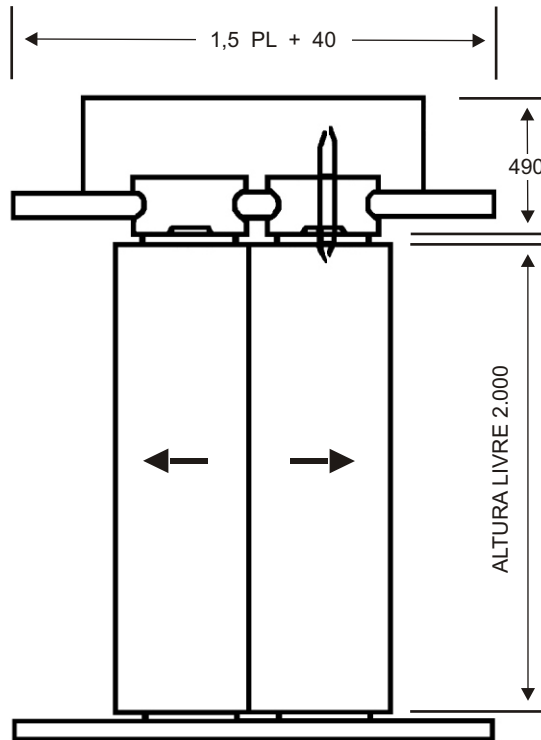

DETALHE A

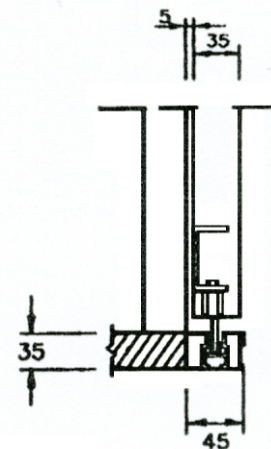

**SUPOORTE DO OPERADOR**

PL	A máxima
700 a 900	960
1.000 a 1.200	1.260

**OPERADOR DE 2 FOLHAS LATERAL PARA PORTA SEMI-AUTOMÁTICA**

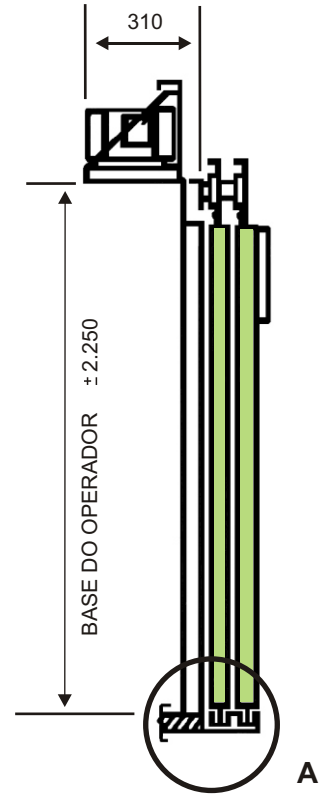
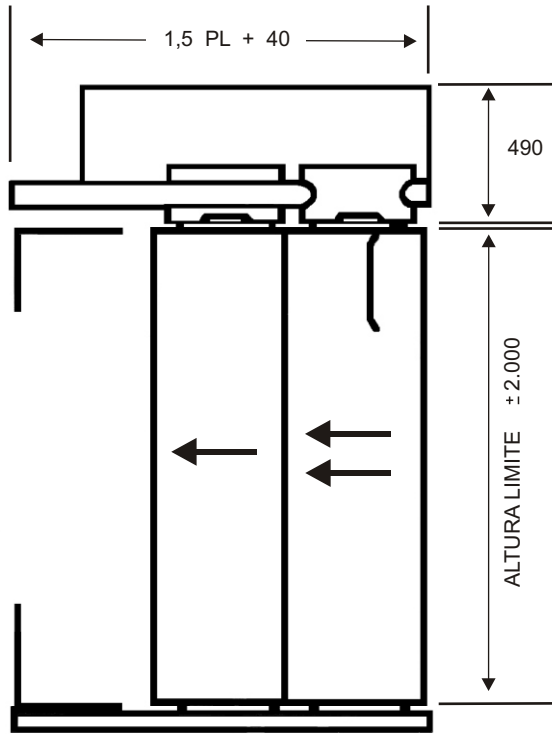

DETALHE A

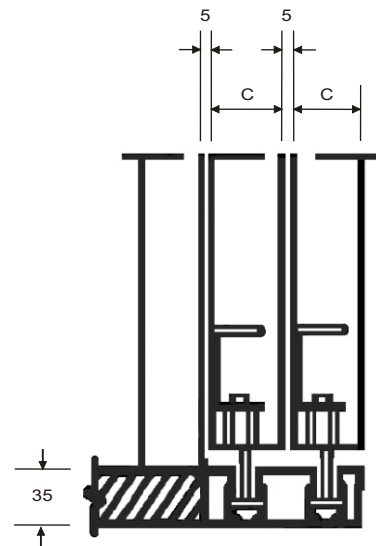
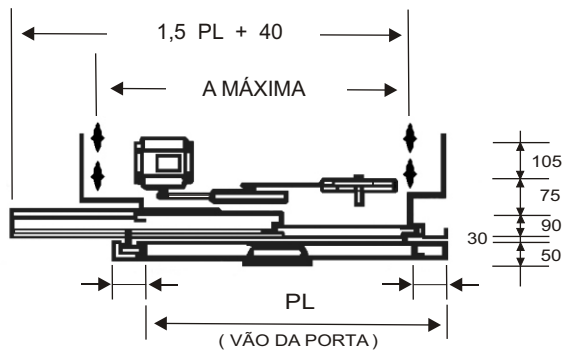

B	C	
90	35	EUROPÉIA
133	30	ATLAS

**OPERADOR DE 3 FOLHAS LATERAL PARA PORTA AUTOMÁTICA**

5 / 5

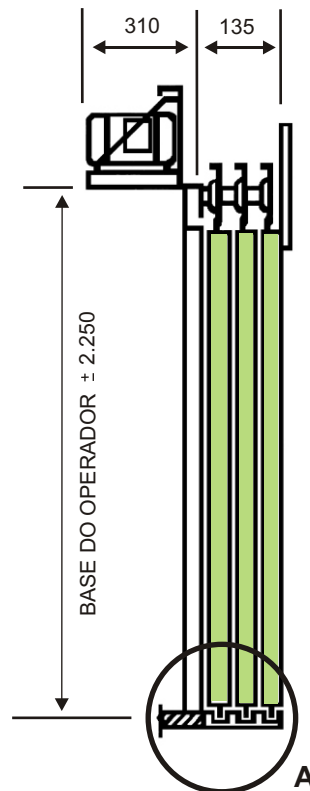
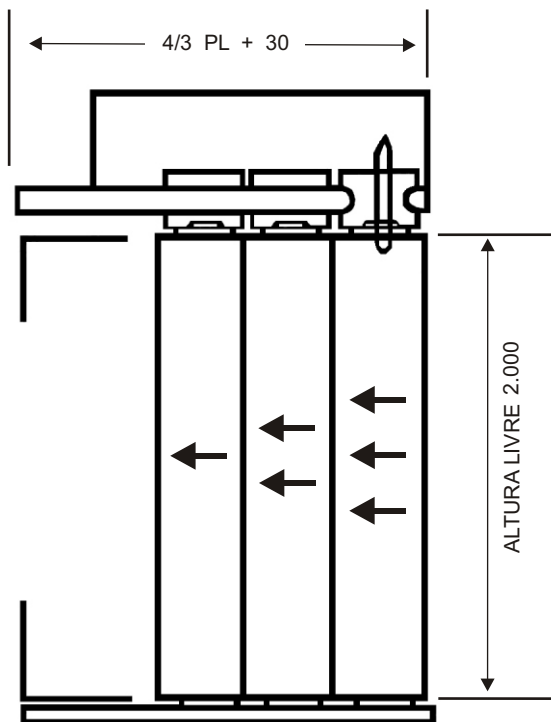

DETALHE A

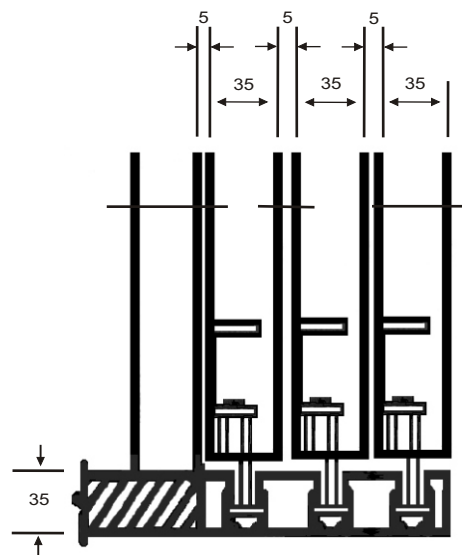
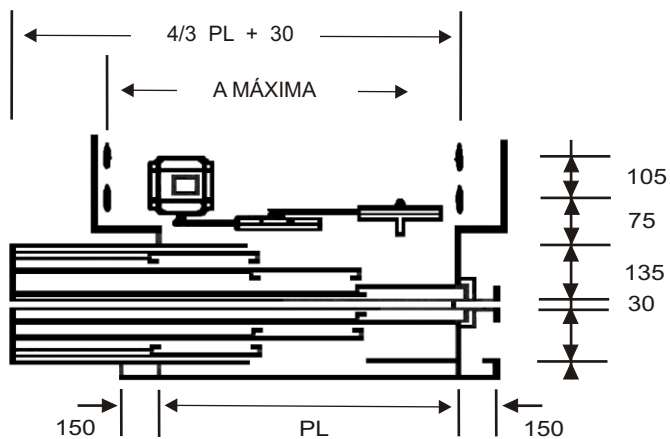

**SUPOORTE DO OPERADOR**

PL	A máxima
700 a 900	960
1.000 a 1.200	1.260